

SPECIFICATION

STAGE V



WHEELED EXCAVATOR | JS145W

Engine power: 97kW (130hp) Bucket capacity: 0.23 – 0.78m³ Operating weight: 14,615 – 17,226kg



STRENGTH & DURABILITY.

With JCB excavators, strength and durability come as standard. Advanced design, manufacturing and assembly produces high quality components designed to last.



PRODUCTIVITY & PERFORMANCE.

Our wheeled excavator range is designed to make the most efficient use of your time and money using innovative Stage V features.

A COMFORTABLE OFFICE.

Our excavator cab houses a range of advanced technology features alongside ergonomic design, to create a comfortable working environment for operators.



MINIMUM DOWNTIME.

Automatic regeneration minimises downtime, while features such as autostop and auto-idle reduce idle time.

GREATER SERVICEABILITY.

Our excavator range is designed to be low maintenance and easily serviceable. When maintenance needs to be carried out, it will be quick and easy.

THE SAFE CHOICE.

Operator and site safety are of major importance. That's why our machines incorporate many features that minimise risk and create a safer environment.

STATIC DIMENSIONS

MAX. OPERATING WEIGHT: 17226kg ENGINE POWER: 97kW (130hp)

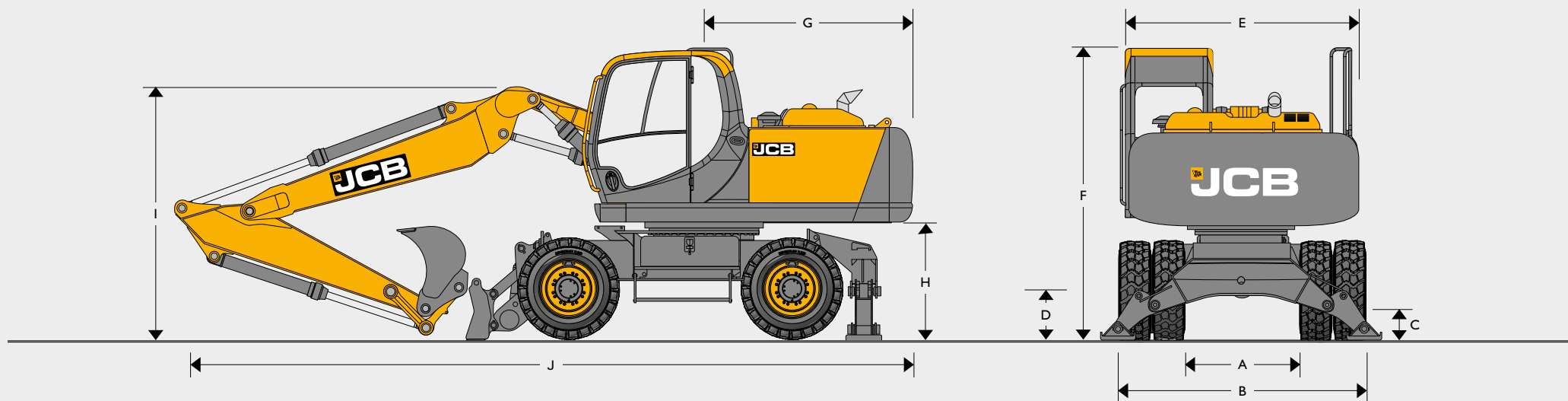

STATIC DIMENSIONS

A	Internal width between dual wheels	mm		1330
B	External width over dual wheels	mm		2498 (JCB), 2528 (ZF)
C	Ground clearance	mm		350
D	Height to axle centre line dual wheels	mm		498
	Height to axle centre line single wheels	mm		519
E	Overall width (handrail removed)	mm		2410
F	Height over cab	mm		3161
G	Tail length	mm		2135
H	Clearance under counterweight	mm		1240

Monoboam 4.7m

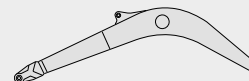

Dipper length		2.10m	2.50m	3.0m
I	Transport boom height	mm	3040	3040
J	Transport length	mm	7665	7715

TAB 5.0m

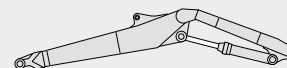

Dipper length		2.10m	2.50m	3.0m
I	Transport boom height	mm	3040	3040
J	Transport length	mm	7395	7975

CHASSIS OPTIONS

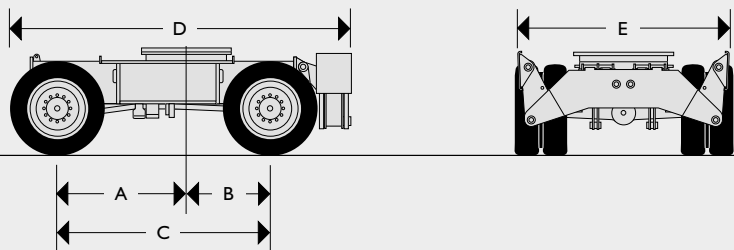

STABILISERS REAR

A	Centre of slew ring to front axle	mm	1500
B	Centre of slew ring to rear axle	mm	1000
C	Wheelbase	mm	2500
D	Length including rear stabilizers	mm	3950
E	Width over stabilizers (raised)	mm	2480

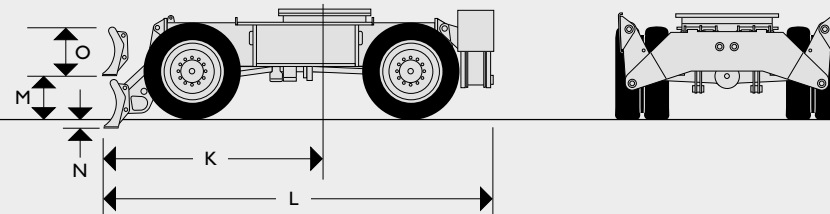

DOZER FRONT STABILISER

K	Centre of slew ring to front dozer blade (lowered)	mm	2530
L	Length including stabilizers and dozer blade (raised)	mm	4460
M	Ground level to bottom of front dozer blade (raised)	mm	450
N	Dozer blade dig depth	mm	130
O	Dozer blade height	mm	500

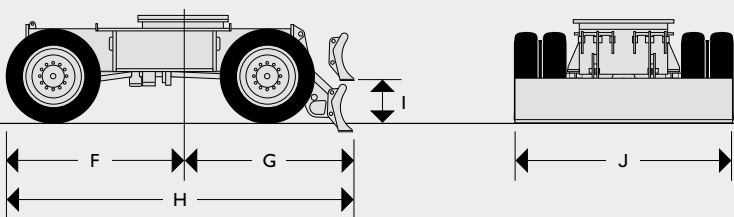

DOZER REAR

F	Centre of slew ring to face of front tyre	mm	1990
G	Centre of slew ring to rear dozer blade (lowered)	mm	2090
H	Length including rear dozer blade (raised)	mm	4050
I	Ground level to bottom of rear dozer blade (raised)	mm	450
J	Dozer blade width	mm	2480

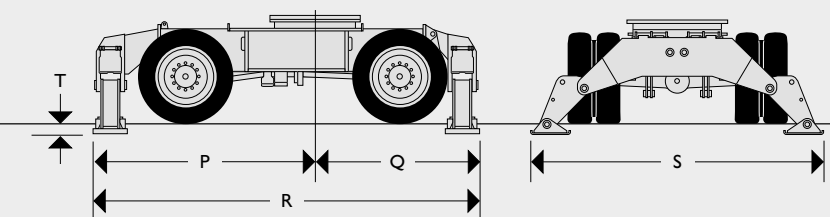

STABILISERS FRONT & REAR

P	Centre of slew ring to front stabilizers	mm	2520
Q	Centre of slew ring to rear stabilizers	mm	1960
R	Length including front and rear stabilizers	mm	4480
S	Width over stabilizers (lowered)	mm	3550
T	Stabilizer lift height	mm	130

ENGINE	
Model	JCB DIESELMAX 448 TCA EU Stage V
Type	4-stroke, 4-cylinder in-line, common rail, direct injection, turbo charged and intercooled diesel
Rated power (ISO 14396)	97kW (130hp) @ 2200rpm
Piston displacement	4.765 litres
Injection	Electronic injection.
Air filtration	Dry element with secondary safety element and in cab warning indicator.
Cooling	Large capacity radiator
Starting system	24 volt – 4kW.
Batteries	2 x 12 volt Heavy Duty
Alternator	24 volt 100 amp
Refuelling pump	Electric type (optional)







SWING SYSTEM	
Drive train	Axial piston motor and planetary reduction final drive.
Swing brake	Hydraulic braking plus automatic spring applied disc type parking brake.
Swing speed	12.6rpm
Swing gear	Large diameter, internally toothed fully sealed grease bath lubricated.
Swing lock	Multi position switchable brake and mechanical lock.

EXCAVATOR END	
<p>Monoboam and triple articulating boom available along with a choice of dipper lengths to suit the requirements of reach, dig-depth, loadover height, tearouts and site versatility. Reserve strength is built into the fully welded structures for hydraulic hammer and other arduous operations.</p> <p>Fabricated bucket tipping links are provided with a choice of lift points.</p> <p>Strong, durable construction, large cross sections and multi plate fabrications to withstand high stress applications.</p>	

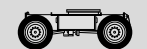
CHASSIS			
Chassis options			
Dozer blade	Front or rear pin mount.		
Stabilisers	Front or rear pin mount, independently operable – plus combinations.		
Grab stowage	Heavy duty, pin mounted stowage bar.		
Axles	Four wheel drive.		
Axle load capacity	25 tonnes (JCB), 32 tonnes (ZF)		
Axle oscillation	+/- 8.5 degrees.		
Ground clearance	350mm.		
Transmission	Hydrostatic drive via piston motor and powershift transmission.		
Travel speed	Creep speed	3.1 kph (JCB)	3.1 kph (ZF)
	Low ratio	8.1 kph (JCB)	7.9kph (ZF)
	High ratio	33.5kph (JCB)	32.3kph (ZF)
Drawbar pull	86.6 kN (JCB Axle), 87.8 kN (ZF Axle)		
Steering	Fully hydraulic system.		
Turning radius			
	To outside of tyres	6.66m (JCB), 6.22 (ZF)	
	To outer edge of front mounted dozer blade	7.09m (JCB), 6.67 (ZF)	
Brakes	All hydraulic, dual circuit brake system.		
Parking brake	Built into the transmission.		
Gradability	35° 70% max. continuous.		

TYRES			
	Twins	Single	Flotation
	10.00 x 20 tyres (16PR) with spacer ring	18R x 19.5 tyres (Radials)	600/40 x 22.5

OPERATING WEIGHTS

Chassis					
	14651kg	15522kg	15636kg	16507kg	16621kg
	15296kg	16167kg	16281kg	17152kg	17266kg
JSI145W	Machine equipped with 3.0m arm, excavating bucket and dual wheels. For single wheels subtract 400kg. For 2.5m arm subtract 76kg. For 2.1m arm subtract 122kg.				

BUCKET AND ARM COMBINATION

Arm length	No quickhitch fitted			Quickhitch fitted*			Bucket weight
	2.25m	2.7m	3.05m	2.25m	2.7m	3.05m	
JSI145W Mono							
GP bucket 457mm 0.23m ³	☐	☐	☐	☐	☐	☐	284kg
GP bucket 610mm 0.30m ³	☐	☐	☐	☐	☐	☐	308kg
GP bucket 762mm 0.42m ³	☐	☐	☐	☐	☐	☐	346kg
GP bucket 915mm 0.54m ³	☐	☐	☐	☐	☐	☐	346kg
GP bucket 1067mm 0.66m ³	☐	☐	☐	☐	☐	■	442kg
GP bucket 1219mm 0.78m ³	☐	■	●	■	■	●	478kg
JSI145W Tab							
GP bucket 457mm 0.23m ³	☐	☐	☐	☐	☐	☐	284kg
GP bucket 610mm 0.30m ³	☐	☐	☐	☐	☐	☐	308kg
GP bucket 762mm 0.42m ³	☐	☐	☐	☐	☐	☐	346kg
GP bucket 915mm 0.54m ³	☐	☐	☐	☐	☐	■	346kg
GP bucket 1067mm 0.66m ³	☐	☐	■	■	■	●	442kg
GP bucket 1219mm 0.78m ³	■	■	●	●	●	×	478kg

Notes: Bucket compatibility based upon lift values (ISO 10567) for a rear dozer machine, compatibility will change based upon chassis options.

☐ = Suitable for general excavating (materials up to 2000kg/cu.m)

■ = Suitable for light excavating (materials up to 1600kg/cu.m)

● = Suitable for grading & loading (materials up to 1200kg/cu.m)

×

* Bucket capacity using JCB quickhitch only (quickhitch = 193kg)

SERVICE CAPACITIES

Fuel tank	litres	220
Engine coolant	litres	19.7
Engine oil	litres	20.4
Swing reduction gear	litres	2.2
Hydraulic system	litres	124
Hydraulic tank	litres	73
Transmission	litres	2.5
Axle differentials (each)	litres	Rear 12, Front 14
Axle hubs (each)	litres	2.0
DEF fluid capacity (if applicable)		31.4

MAIN HYDRAULIC SYSTEM

System	Open centred, negative control hydraulic system with twin variable flow piston pumps providing flow-on-demand for maximum efficiency.
Main pumps	2 variable displacement axial piston type.
Maximum flow	2 x 123 l/min
Main circuit pressure	314 bar
With power boost	343 bar
Servo pump	Gear type
Maximum flow	19 l/min
Servo pressure	40 bar
Optional circuits	
Hammer	Includes automatic engine speed setting and return filter.
Maximum flow	119 l/min
Maximum pressure	314 bar (pre-set to 210 bar)
Aux double acting	
Maximum flow	123 l/min
Maximum pressure for grab ram operation	314 (343) bar
Low flow pipework	34 l/min
Hydraulic cylinders	Hardened, chromed piston rods and end cushioning on boom, dipper and bucket crowd cylinder.
Filtration	
In tank	150 micron, suction strainer.
Main return line	10 micron, fibreform element.
Pilot line	10 micron, paper element.
Hydraulic hammer return	10 micron, reinforced microform element.
Cooling	Worldwide cooling is provided by a single faced engine water, hydraulic oil and intercooler with swing forwards air conditioning condenser for easy cleaning.

WORKING RANGES – JSI45W

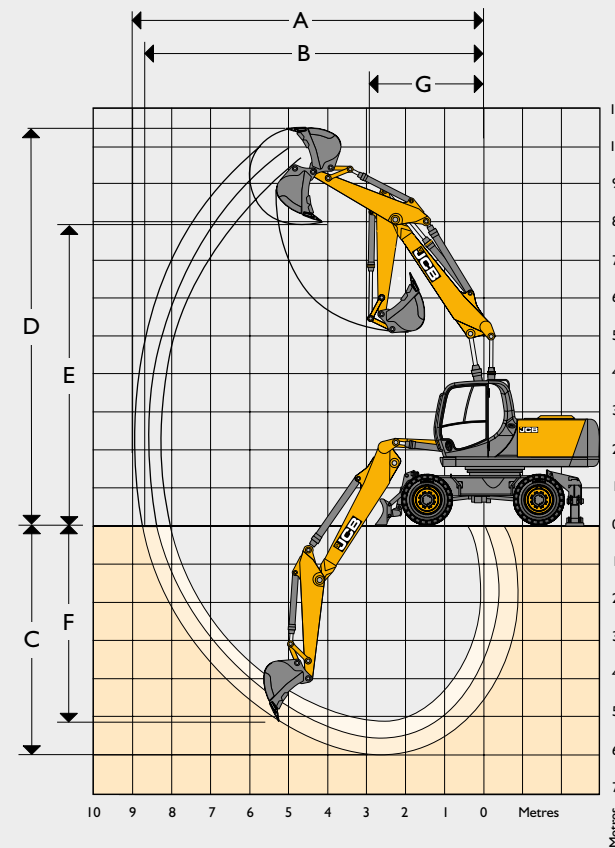
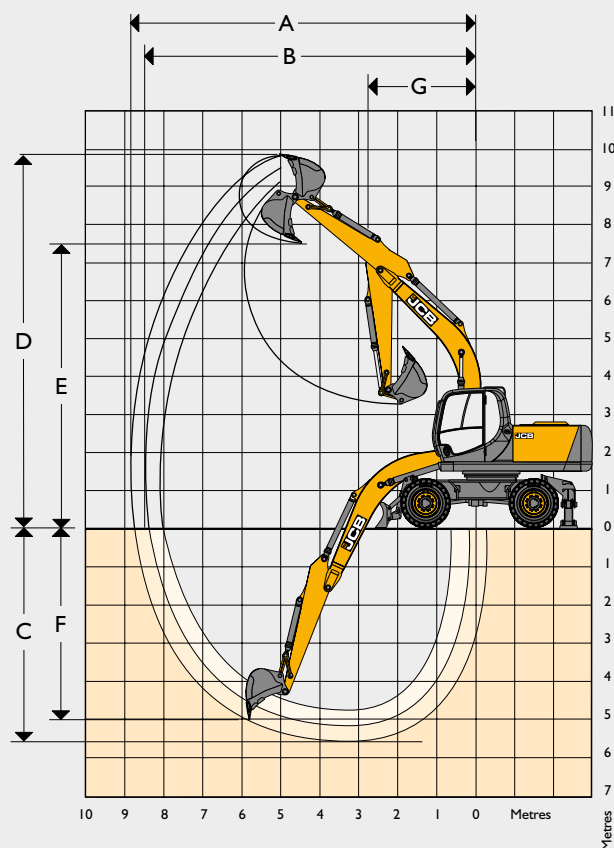











4.7m Monoboom

Dipper length		2.10m	2.50m	3.00m
A	Max digging reach	mm 7980	8350	8800
B	Max digging reach (on ground)	mm 7745	8125	8585
C	Max digging depth	mm 4775	5175	5675
D	Max digging height	mm 9185	9455	9775
E	Max loadover height	mm 6780	7050	7400
F	Max vertical wall cut depth	mm 4200	4600	5050
G	Min swing radius	mm 2050	2050	2410
	Bucket rotation	182°	182°	182°
	Dipper tearout	kgf 8843	7430	6190
	Dipper tearout with boost	kgf 9570	8040	6700
	Bucket tearout	kgf 7720	7720	7720
	Bucket tearout with boost	kgf 8350	8350	8350











5.0m T.A.B.

Dipper length		2.10m	2.50m	3.00m
A	Max digging reach	mm 8360	8750	9235
B	Max digging reach (on ground)	mm 8140	8525	9000
C	Max digging depth	mm 5020	5425	5930
D	Max digging height	mm 9675	10000	10400
E	Max loadover height	mm 7275	7575	7950
F	Max vertical wall cut depth	mm 4240	4625	5105
G	Min swing radius	mm 2490	2575	2680
	Bucket rotation	182°	182°	182°
	Dipper tearout	kgf 8843	7430	6190
	Dipper tearout with boost	kgf 9570	8040	6700
	Bucket tearout	kgf 7720	7720	7720
	Bucket tearout with boost	kgf 8350	8350	8350











LIFT CAPACITIES – DIPPER LENGTH: 2.10M, 4.70M MONOBOOM, REAR DOZER, NO BUCKET. JSI45W MONO

Reach	3m		4m		5m		6m		Capacity at Max Reach		mm
											
Load Point Ht.	kg	kg	kg	kg	kg	kg	kg	kg	kg	kg	mm
6.0m			3240*	3240*	3350*	3350*			2810*	2810*	5368
5.0m	3810*	3810*	3540*	3540*	3400*	3400*	2750*	2600	2660*	2590	6011
4.0m	5090*	5090*	4150*	4150*	3690*	3410	3480*	2580	2620*	2310	6434
3.0m	6840*	6840*	4950*	4550	4110*	3300	3670*	2530	2650*	2150	6679
2.0m			5710*	4360	4540*	3200	3900*	2480	2740*	2080	6767
1.0m	4750*	4750*	6220*	4230	4880*	3110	4090*	2430	2920*	2080	6704
0m	7050*	6410	6420*	4160	5050*	3060	4170*	2400	3200*	2170	6485
- 1.0m	8310*	6430	6330*	4150	5010*	3050	4020*	2400	3680*	2360	6093
- 2.0m	7630*	6490	5900*	4180	4630	3070			4010*	2730	5490
- 3.0m	6420*	6420*	4920*	4270					4010*	3550	4592

LIFT CAPACITIES – DIPPER LENGTH: 2.10M, 4.70M MONOBOOM, REAR STABILISERS, NO BUCKET. JSI45W MONO

Reach	3m		4m		5m		6m		Capacity at Max Reach		mm
											
Load Point Ht.	kg	kg	kg	kg	kg	kg	kg	kg	kg	kg	mm
6.0m			3240*	3240*	3350*	3350*			2810*	2810*	5368
5.0m	3810*	3810*	3540*	3540*	3400*	3400*	2750*	2750*	2660*	*2660	6011
4.0m	5090*	5090*	4150*	4150*	3690*	3690*	3480*	2920	2620*	2610	6434
3.0m	6840*	6840*	4950*	4950*	4110*	3750	3670*	2870	2650*	2440	6679
2.0m			5710*	5020	4540*	3640	3900*	2810	2740*	2360	6767
1.0m	4750*	4750*	6220*	4880	4880*	3560	4090*	2760	2920*	2370	6704
0m	7050*	7050*	6420*	4810	5050*	3500	4170*	2730	3200*	2460	6485
- 1.0m	8310*	7600	6330*	4800	5010*	3490	4020*	2730	3680*	2680	6093
- 2.0m	7630*	7630*	5900*	4830	4630*	3520			4010*	3110	5490
- 3.0m	6420*	6420*	4920*	4920*					4010*	4010*	4592

LIFT CAPACITIES – DIPPER LENGTH: 2.10M, 4.70M MONOBOOM, FRONT DOZER, REAR STABILISERS, NO BUCKET. JSI45W MONO











Reach	3m		4m		5m		6m		Capacity at Max Reach		mm
											
Load Point Ht.	kg	kg	kg	kg	kg	kg	kg	kg	kg	kg	mm
6.0m			3240*	3240*	3350*	3350*			2810*	2810*	5368
5.0m	3810*	3810*	3540*	3540*	3400*	3400*	2750*	2750*	2660*	2660*	6011
4.0m	5090*	5090*	4150*	4150*	3690*	3690*	3480*	3480*	2620*	2620*	6434
3.0m	6840*	6840*	4950*	4950*	4110*	4110*	3670*	3630	2650*	2650*	6679
2.0m			5710*	5710*	4540*	4540*	3900*	3570	2740*	2740*	6767
1.0m	4750*	4750*	6220*	6220*	4880*	4560	4090*	3510	2920*	2920*	6704
0m	7050*	7050*	6420*	6310	5050*	4510	4170*	3480	3200*	3130	6485
- 1.0m	8310*	8310*	6330*	6290	5010*	4490	4020*	3480	3680*	3420	6093
- 2.0m	7630*	7630*	5900*	5900*	4630*	4520			4010*	3980	5490
- 3.0m	6420*	6420*	4920*	4920*					4010*	4010*	4592











 Lift capacity front and rear.











Notes:

1. For lifting capacity including bucket, subtract total weight of bucket or bucket and quickhitch from above values.
2. Lifting capacities are based on ISO 10567, that is: 75% of minimum tipping load or 87% of hydraulic lift capacity, whichever is the less. Lifting capacities marked* are based on hydraulic capacity.
3. Lift capacities assume that the machine is on firm, level ground.
4. Lift capacities may be limited by local regulations. Please refer to your dealer.

 Lift capacity full circle.

LIFT CAPACITIES – DIPPER LENGTH: 2.10M, 4.70M MONOBOOM, FRONT STABILISER, REAR STABILISER, NO BUCKET.											JSI45W MONO
Reach	3m		4m		5m		6m		Capacity at Max Reach		
											
Load Point Ht.	kg	kg	kg	kg	kg	kg	kg	kg	kg	kg	mm
6.0m			3240*	3240*	3350*	3350*			2810*	2810*	5368
5.0m	3810*	3810*	3540*	3540*	3400*	3400*	2750*	2750*	2660*	2660*	6011
4.0m	5090*	5090*	4150*	4150*	3690*	3690*	3480*	3480*	2620*	2620*	6434
3.0m	6840*	6840*	4950*	4950*	4110*	4110*	3670*	3670*	2650*	2650*	6679
2.0m			5710*	5710*	4540*	4540*	3900*	3900*	2740*	2740*	6767
1.0m	4750*	4750*	6220*	6220*	4880*	4880*	4090*	3880*	2920*	2920*	6704
0m	7050*	7050*	6420*	6420*	5050*	5010	4170*	3840*	3200*	3200*	6485
- 1.0m	8310*	8310*	6330*	6330*	5010*	4990	4020*	3850	3680*	3680*	6093
- 2.0m	7630*	7630*	5900*	5900*	4630	4630*			4010*	4010*	5490
- 3.0m	6420*	6420*	4920*	4920*					4010*	4010*	4592

LIFT CAPACITIES – DIPPER LENGTH: 2.50M, 4.70M MONOBOOM, REAR DOZER, NO BUCKET.											JSI45W MONO
Reach	3m		4m		5m		6m		Capacity at Max Reach		
											
Load Point Ht.	kg	kg	kg	kg	kg	kg	kg	kg	kg	kg	mm
6.0m			2850*	2850*	2990*	2990*			2990*	2990*	5828
5.0m			3160*	3160*	3110*	3110*	3130*	2770	2190*	2190*	6424
4.0m	4420*	4420*	3780*	3780*	3440*	3440*	3260*	2730	2160*	2160*	6821
3.0m	6110*	6110*	4600*	4600*	3880*	3490	3490*	2680	2180*	2090	7053
2.0m	7700*	7040	5430*	4620	4360*	3370	3760*	2610	2260*	2030	7136
1.0m	6200*	6200*	6050*	4460	4750*	3280	4000*	2550	2400	2030	7076
0m	7380*	6710	6380*	4370	5010*	3210	4150*	2510	2620*	2100	6869
- 1.0m	8560*	6700	6410*	4340	5060*	3180	4130*	2500	2970*	2260	6501
- 2.0m	8030*	6740	6130*	4350	4840*	3190			3590*	2560	5940
- 3.0m	7060*	6840	5420*	4410	4090*	3260			3900*	3160	5124

LIFT CAPACITIES – DIPPER LENGTH: 2.50M, 4.70M MONOBOOM, REAR STABILISERS, NO BUCKET.											JSI45W MONO
Reach	3m		4m		5m		6m		Capacity at Max Reach		
											
Load Point Ht.	kg	kg	kg	kg	kg	kg	kg	kg	kg	kg	mm
6.0m			2850*	2850*	2990*	2990*			2290*	2290*	5828
5.0m			3160*	3160*	3110*	3110*	3130*	3000	2190*	2190*	6424
4.0m	4420*	4420*	3780*	3780*	3440*	3440*	3260*	2960	2160*	2160*	6821
3.0m	6110*	6110*	4600*	4600*	3880*	3800	3490*	2900	2180*	2180*	7053
2.0m	7700*	7040	5430*	5100	4360*	3680	3760*	2840	2260*	2200	7136
1.0m	6200*	6200*	6050*	4930	4750*	3590	4000*	2780	2400	2200	7076
0m	7380*	7380*	6380*	4840	5010*	3520	4150*	2740	2620*	2280	6869
- 1.0m	8560*	7590	6410*	4800	5060*	3490	4130*	2720	2970*	2450	6501
- 2.0m	8030*	7640	6130*	4820	4840*	3500			3590*	2780	5940
- 3.0m	7060*	7060*	5420*	4880	4090*	3560			3900*	3450	5124











 Lift capacity front and rear.

Notes:











1. For lifting capacity including bucket, subtract total weight of bucket or bucket and quickhitch from above values.
2. Lifting capacities are based on ISO 10567, that is: 75% of minimum tipping load or 87% of hydraulic lift capacity, whichever is the less. Lifting capacities marked* are based on hydraulic capacity.
3. Lift capacities assume that the machine is on firm, level ground.
4. Lift capacities may be limited by local regulations. Please refer to your dealer.

 Lift capacity full circle.





LIFT CAPACITIES – DIPPER LENGTH: 2.50M, 4.70M MONOBOOM, FRONT DOZER, REAR STABILISER, NO BUCKET. JSI45W MONO

Reach	3m		4m		5m		6m		Capacity at Max Reach		mm
											
Load Point Ht.	kg	kg	kg	kg	kg	kg	kg	kg	kg	kg	mm
6.0m			2850*	2850*	2990*	2990*			2290*	2290*	5828
5.0m			3160*	3160*	3110*	3110*	3130*	3130*	2190*	2190*	6424
4.0m	4420*	4420*	3780*	3780*	3440*	3440*	3260*	3260*	2160*	2160*	6821
3.0m	6110*	6110*	4600*	4600*	3880*	3880*	3490*	3490*	2180*	2180*	7053
2.0m	7700*	7700*	5430*	5430*	4360*	4360*	3760*	3590	2260*	2260*	7136
1.0m	6200*	6200*	6050*	6050*	4750*	4590	4000*	3530	2400*	2400*	7076
0m	7380*	7380*	6380*	6330	5010*	4520	4150*	3490	2620*	2620*	6869
- 1.0m	8560*	8560*	6410*	6290	5060*	4490	4130*	3470	2970*	2970*	6501
- 2.0m	8030*	8030*	6130*	6130	4840*	4500			3590*	3550	5940
- 3.0m	7060*	7060*	5420*	5420*	4090*	4090*			3900*	3900*	5124

LIFT CAPACITIES – DIPPER LENGTH: 2.50M, 4.70M MONOBOOM, FRONT STABILISER, REAR STABILISER, NO BUCKET. JSI45W MONO

Reach	3m		4m		5m		6m		Capacity at Max Reach		mm
											
Load Point Ht.	kg	kg	kg	kg	kg	kg	kg	kg	kg	kg	mm
6.0m			2850*	2850*	2990*	2990*			2290*	2290*	5828
5.0m			3160*	3160*	3110*	3110*	3130*	3130*	2190*	2190*	6424
4.0m	4420*	4420*	3780*	3780*	3440*	3440*	3260*	3260*	2160*	2160*	6821
3.0m	6110*	6110*	4600*	4600*	3880*	3880*	3490*	3490*	2180*	2180*	7053
2.0m	7700*	7700*	5430*	5430*	4360*	4360*	3760*	3760*	2260*	2260*	7136
1.0m	6200*	6200*	6050*	6050*	4750*	4750*	4000*	3890*	2400*	2400*	7076
0m	7380*	7380*	6380*	6380*	5010*	5010*	4150*	3850*	2620*	2620*	6869
- 1.0m	8560*	8560*	6410*	6410*	5060*	4990	4130*	3830	2970*	2970*	6501
- 2.0m	8030*	8030*	6130*	6130*	4840*	4840*			3590*	3590*	5940
- 3.0m	7060*	7060*	5420*	5420*	4090*	4090*			3900*	3900*	5124

LIFT CAPACITIES – DIPPER LENGTH: 3.00M, 4.70M MONOBOOM, REAR DOZER, NO BUCKET. JSI45W MONO

Reach	3m		4m		5m		6m		Capacity at Max Reach		mm
											
Load Point Ht.	kg	kg	kg	kg	kg	kg	kg	kg	kg	kg	mm
6.0m					2590*	2590*	2800*	2730	2120*	2120*	6380
5.0m					2750*	2750*	2810*	2720	2050*	2050*	6928
4.0m					3290*	3290*	3100*	2990*	2030*	1960	7297
3.0m	5220*	5220*	4130*	4130*	3580*	3420	3270*	2610	2050*	1850	7514
2.0m	6950*	6950*	5020*	4530	4100*	3290	3580*	2540	2120*	1790	7593
1.0m	7730*	6640*	5770*	4350	4560*	3190	3860*	2740	2240*	1790	7536
0m	7680*	6480	6250*	4230	4900*	3100	4080*	2420	2430*	1840	7342
- 1.0m	8720*	6420	6430*	4170	5060*	3060	4170*	2390	2720*	1950	6999
- 2.0m	8400*	6430	6320*	4150	4990*	3040	4040*	2390	3190*	2170	6483
- 3.0m	7680*	6500	5850*	4190	4580*	3070			3720*	2570	5746









 Lift capacity front and rear.

 Lift capacity full circle.

Notes:

1. For lifting capacity including bucket, subtract total weight of bucket or bucket and quickhitch from above values.
2. Lifting capacities are based on ISO 10567, that is: 75% of minimum tipping load or 87% of hydraulic lift capacity, whichever is the less. Lifting capacities marked* are based on hydraulic capacity.
3. Lift capacities assume that the machine is on firm, level ground.
4. Lift capacities may be limited by local regulations. Please refer to your dealer.

LIFT CAPACITIES – DIPPER LENGTH: 3.00M, 4.70M MONOBOOM, REAR STABILISERS, NO BUCKET. JSI45W MONO

Reach	3m		4m		5m		6m		Capacity at Max Reach		mm
											
Load Point Ht.	kg	kg	kg	kg	kg	kg	kg	kg	kg	kg	mm
6.0m					2590*	2590*	2800*	2800*	2120*	2120*	6380
5.0m			2670*	2670*	2750*	2750*	2810*	2810*	2050*	2050*	6928
4.0m			3290*	3290*	3100*	3100*	2990*	2990*	2030*	2030*	7297
3.0m	5220*	5220*	4130*	4130*	3580*	3580*	3270*	2950	2050*	2050*	7514
2.0m	6950*	6950*	5020*	5020*	4100*	3740	3580*	2880	2120*	2030	7593
1.0m	7730*	7730*	5770*	5010	4560*	3630	3860*	2810	2240*	2030	7536
0m	7680*	7650	6250*	4880	4900*	3550	4080*	2760	2430*	2090	7342
- 1.0m	8720*	7600	6430*	4820	5060*	3500	4170*	2720	2720*	2220	6999
- 2.0m	8400*	7610	6320*	4800	4990*	3490	4040*	2720	3190*	2470	6483
- 3.0m	7680*	7680	5850*	4840	4580*	3520			3720*	2930	5746

LIFT CAPACITIES – DIPPER LENGTH: 3.00M, 4.70M MONOBOOM, FRONT DOZER, REAR STABILISERS, NO BUCKET. JSI45W MONO

Reach	3m		4m		5m		6m		Capacity at Max Reach		mm
											
Load Point Ht.	kg	kg	kg	kg	kg	kg	kg	kg	kg	kg	mm
6.0m					2590*	2590*	2800*	2800*	2120*	2120*	6380
5.0m			2670*	2670*	2750*	2750*	2810*	2810*	2050*	2050*	6928
4.0m			3290*	3290*	3100*	3100*	2990*	2990*	2030*	2030*	7297
3.0m	5220*	5220*	4130*	4130*	3580*	3580*	3270*	3270*	2050*	2050*	7514
2.0m	6950*	6950*	5020*	5020*	4100*	4100*	3580*	3580*	2120*	2120*	7593
1.0m	7730*	7730*	5770*	5770*	4560*	4560*	3860*	3560	2240*	2240*	7536
0m	7680*	7680*	6250*	6250*	4900*	4550	4080*	3510	2430*	2430*	7342
- 1.0m	8720*	8720*	6430*	6310	5060*	4500	4170*	3480	2720*	2720*	6999
- 2.0m	8400*	8400*	6320*	6300	4990*	4490	4040*	3470	3190*	3130	6483
- 3.0m	7680*	7680*	5850*	5850*	4580*	4520			3720*	3720*	5746

LIFT CAPACITIES – DIPPER LENGTH: 3.00M, 4.70M MONOBOOM, FRONT STABILISERS, REAR STABILISERS, NO BUCKET. JSI45W MONO











Reach	3m		4m		5m		6m		Capacity at Max Reach		mm
											
Load Point Ht.	kg	kg	kg	kg	kg	kg	kg	kg	kg	kg	mm
6.0m					2590*	2590*	2800*	2800*	2120*	2120*	6380
5.0m			2670*	2670*	2750*	2750*	2810*	2810*	2050*	2050*	6928
4.0m			3290*	3290*	3100*	3100*	2990*	2990*	2030*	2030*	7297
3.0m	5220*	5220*	4130*	4130*	3580*	3580*	3270*	3270*	2050*	2050*	7514
2.0m	6950*	6950*	5020*	5020*	4100*	4100*	3580*	3580*	2120*	2120*	7593
1.0m	7730*	7730*	5770*	5770*	4560*	4560*	3860*	3860*	2240*	2240*	7536
0m	7680*	7680*	6250*	6250*	4900*	4900*	4080*	3870	2430*	2430*	7342
- 1.0m	8720*	8720*	6430*	6430*	5060*	5000	4170*	3840	2720*	2720*	6999
- 2.0m	8400*	8400*	6320*	6320*	4990*	4990	4040*	3830	3190*	3190*	6483
- 3.0m	7680*	7680*	5850*	5850*	4580*	4580*			3720*	3720*	5746











 Lift capacity front and rear.











 Lift capacity full circle.

Notes:

1. For lifting capacity including bucket, subtract total weight of bucket or bucket and quickhitch from above values.
2. Lifting capacities are based on ISO 10567, that is: 75% of minimum tipping load or 87% of hydraulic lift capacity, whichever is the less. Lifting capacities marked* are based on hydraulic capacity.
3. Lift capacities assume that the machine is on firm, level ground.
4. Lift capacities may be limited by local regulations. Please refer to your dealer.

LIFT CAPACITIES – DIPPER LENGTH: 2.10M, 5.00M T.A.B., REAR DOZER, NO BUCKET.											JSI45W T.A.B.
Reach	3m		4m		5m		6m		Capacity at Max Reach		
											
Load Point Ht.	kg	kg	kg	kg	kg	kg	kg	kg	kg	kg	mm
6.0m			3260*	3260*	3180*	3180*			2910*	2660*	5868
5.0m	4160*	4160*	3620*	3620*	3330*	3330*	3200*	2580	2720*	2260*	6461
4.0m	5490*	5490*	4250*	4250*	3640*	3350	3320*	2540	2640*	2040	6856
3.0m			5010*	4420	4050*	3220	3530*	2470	2630*	1910	7086
2.0m			5680*	4200	4440*	3090	3760*	2400	2670*	1850	7169
1.0m			6080*	4060	4740*	3000	3940*	2340	2770*	1860	7110
0m			6200*	4010	4880*	2950	4020*	2310	2970*	1930	6903
- 1.0m	6980*	6260	6060*	4010	4820*	2940	3930*	2310	3260*	2090	6537
- 2.0m	7160*	6340	5650*	4060	4510*	2970			3430*	2380	5980

LIFT CAPACITIES – DIPPER LENGTH: 2.10M, 5.00M T.A.B., REAR STABILISERS, NO BUCKET.											JSI45W T.A.B.
Reach	3m		4m		5m		6m		Capacity at Max Reach		
											
Load Point Ht.	kg	kg	kg	kg	kg	kg	kg	kg	kg	kg	mm
6.0m			3260*	3260*	3180*	3180*			2910*	2910*	5868
5.0m	4160*	4160*	3620*	3620*	3330*	3330*	3200*	2930	2720*	2570	6461
4.0m	5490*	5490*	4250*	4250*	3640*	3640*	3320*	2880	2640*	2320	6856
3.0m			5010*	5010*	4050*	3680	3530*	2810	2630*	2180	7086
2.0m			5680*	4870	4440*	3550	3760*	2740	2670*	2120	7169
1.0m			6080*	4730	4740*	3450	3940*	2690	2770*	2130	7110
0m			6200*	4670	4880*	3400	4020*	2650	2970*	2210	6903
- 1.0m	6980*	6980*	6060*	4670	4820*	3390	3930*	2650	3260*	2390	6537
- 2.0m	7160*	7160*	5650*	4720	4510*	3420			3430*	2720	5980

LIFT CAPACITIES – DIPPER LENGTH: 2.10M, 5.00M T.A.B., FRONT DOZER, REAR STABILISERS, NO BUCKET.											JSI45W T.A.B.
Reach	3m		4m		5m		6m		Capacity at Max Reach		
											
Load Point Ht.	kg	kg	kg	kg	kg	kg	kg	kg	kg	kg	mm
6.0m			3260*	3260*	3180*	3180*			2910*	2910*	5868
5.0m	4160*	4160*	3620*	3620*	3330*	3330*	3200*	3200*	2720*	2720*	6461
4.0m	5490*	5490*	4250*	4250*	3640*	3640*	3320*	3320*	2640*	2640*	6856
3.0m			5010*	5010*	4050*	4050*	3530*	3530*	2630*	2630*	7086
2.0m			5680*	5680*	4440*	4440*	3760*	3510	2670*	2670*	7169
1.0m			6080*	6080*	4740*	4470	3940*	3450	2770*	2720	7110
0m			6200*	6180	4880*	4420	4020*	3420	2970*	2830	6903
- 1.0m	6980*	6980*	6060*	6060*	4820*	4410	3930*	3410	3260*	3060	6537
- 2.0m	7160*	7160*	5650*	5650*	4510*	4440			3430*	3430*	5980

 Lift capacity front and rear.







 Lift capacity full circle.

Notes:

1. For lifting capacity including bucket, subtract total weight of bucket or bucket and quickhitch from above values.
2. Lifting capacities are based on ISO 10567, that is: 75% of minimum tipping load or 87% of hydraulic lift capacity, whichever is the less. Lifting capacities marked* are based on hydraulic capacity.
3. Lift capacities assume that the machine is on firm, level ground.
4. Lift capacities may be limited by local regulations. Please refer to your dealer.

LIFT CAPACITIES – DIPPER LENGTH: 2.10M, 5.00M T.A.B., FRONT STABILISERS, REAR STABILISERS, NO BUCKET.

JSI45W T.A.B.

Reach	3m		4m		5m		6m		Capacity at Max Reach		mm
											
Load Point Ht.	kg	kg	kg	kg	kg	kg	kg	kg	kg	kg	mm
6.0m			3260*	3260*	3180*	3180*			2910*	2910*	5868
5.0m	4160*	4160*	3620*	3620*	3330*	3330*	3200*	3200*	2720*	2720*	6461
4.0m	5490*	5490*	4250*	4250*	3640*	3640*	3320*	3320*	2640*	2640*	6856
3.0m			5010*	5010*	4050*	4050*	3530*	3530*	2630*	2630*	7086
2.0m			5680*	5680*	4440*	4440*	3760*	3760*	2670*	2670*	7169
1.0m			6080*	6080*	4740*	4470	3940*	3820	2770*	2770*	7110
0m			6200*	6200*	4880*	4880*	4020*	3780	2970*	2970*	6903
- 1.0m	6980*	6980*	6060*	6060*	4820*	4820*	3930*	3780	3260*	3260*	6537
- 2.0m	7160*	7160*	5650*	5650*	4510*	4510*			3430*	3430*	5980

LIFT CAPACITIES – DIPPER LENGTH: 2.50M, 5.00M T.A.B., REAR DOZER, NO BUCKET.

JSI45W T.A.B.

Reach	3m		4m		5m		6m		Capacity at Max Reach		mm
											
Load Point Ht.	kg	kg	kg	kg	kg	kg	kg	kg	kg	kg	mm
6.0m			2930*	2930*	2910*	2910*	2970*	2760	2350*	2350*	6335
5.0m			3290*	3290*	3090*	3090*	2980*	2750	2230*	2170	6886
4.0m	4850*	4850*	3910*	3910*	3420*	3420*	3140*	2690	2170*	1980	7258
3.0m			4690*	4690*	3850*	3410	3380*	2620	2160*	1860	7476
2.0m			5430*	4470	4280*	3280	3640*	2540	2210*	1810	7554
1.0m			5950*	4300	4630*	3170	3860*	2470	2280*	1820	7498
0m	4360*	4360*	6180*	4220	4840*	3100	3990*	2430	2430*	1880	7303
- 1.0m	6730*	6510	6160*	4200	4870*	3080	3990*	2410	2660*	2010	6958
- 2.0m	7590*	6580	5870*	4220	4680*	3090	3750*	2430	3040*	2240	6438
- 3.0m			5240*	4300	4120*	3150			3600*	2820	5455

LIFT CAPACITIES – DIPPER LENGTH: 2.50M, 5.00M T.A.B., REAR STABILISERS, NO BUCKET.

JSI45W T.A.B.

Reach	3m		4m		5m		6m		Capacity at Max Reach		mm
											
Load Point Ht.	kg	kg	kg	kg	kg	kg	kg	kg	kg	kg	mm
6.0m			2930*	2930*	2910*	2910*	2970*	2970*	2350*	2350*	6335
5.0m			3290*	3290*	3090*	3090*	2980*	2980*	2230*	2230*	6886
4.0m	4850*	4850*	3910*	3910*	3420*	3420*	3140*	2930	2170*	2150	7258
3.0m			4690*	4690*	3850*	3730	3380*	2850	2160*	2030	7476
2.0m			5430*	4950	4280*	3600	3640*	2770	2210*	1970	7554
1.0m			5950*	4780	4630*	3490	3860*	2700	2280*	1980	7498
0m	4360*	4360*	6180*	4690	4840*	3420	3990*	2660	2430*	2040	7303
- 1.0m	6730*	6730*	6160*	4670	4870*	3390	3990*	2640	2660*	2190	6958
- 2.0m	7590*	7590*	5870*	4700	4680*	3400	3750*	2660	3040*	2450	6438
- 3.0m			5240*	4780	4120*	3470			3600*	3100	5455

 Lift capacity front and rear.











Notes:

1. For lifting capacity including bucket, subtract total weight of bucket or bucket and quickhitch from above values.
2. Lifting capacities are based on ISO 10567, that is: 75% of minimum tipping load or 87% of hydraulic lift capacity, whichever is the less. Lifting capacities marked* are based on hydraulic capacity.
3. Lift capacities assume that the machine is on firm, level ground.
4. Lift capacities may be limited by local regulations. Please refer to your dealer.













Lift capacity full circle.











LIFT CAPACITIES – DIPPER LENGTH: 2.50M, 5.00M T.A.B., FRONT DOZER, REAR STABILISERS, NO BUCKET. JSI45W T.A.B.

Reach	3m		4m		5m		6m		Capacity at Max Reach		mm
											
Load Point Ht.	kg	kg	kg	kg	kg	kg	kg	kg	kg	kg	mm
6.0m			2930*	2930*	2910*	2910*	2970*	2970*	2350*	2350*	6335
5.0m			3290*	3290*	3090*	3090*	2980*	2980*	2230*	2230*	6886
4.0m	4850*	4850*	3910*	3910*	3420*	3420*	3140*	3140*	2170*	2170*	7258
3.0m			4690*	4690*	3850*	3850*	3380*	3380*	2160*	2160*	7476
2.0m			5430*	5430*	4280*	4280*	3640*	3540	2210*	2210*	7554
1.0m			5950*	5950*	4630*	4510	3860*	3470	2280*	2280*	7498
0m	4360*	4360*	6180*	6180*	4840*	4440	3990*	3420	2430*	2430*	7303
- 1.0m	6730*	6730*	6160*	6160*	4870*	4410	3990*	3410	2660*	2660*	6958
- 2.0m	7590*	7590*	5870*	5870*	4680*	4420	3750*	3430	3040*	3040*	6438
- 3.0m			5240*	5240*	4120*	4120*			3600*	3600*	5455

LIFT CAPACITIES – DIPPER LENGTH: 2.50M, 5.00M T.A.B., FRONT STABILISERS, REAR STABILISERS, NO BUCKET. JSI45W T.A.B.

Reach	3m		4m		5m		6m		Capacity at Max Reach		mm
											
Load Point Ht.	kg	kg	kg	kg	kg	kg	kg	kg	kg	kg	mm
6.0m			2930*	2930*	2910*	2910*	2970*	2970*	2350*	2350*	6335
5.0m			3290*	3290*	3090*	3090*	2980*	2980*	2230*	2230*	6886
4.0m	4850*	4850*	3910*	3910*	3420*	3420*	3140*	3140*	2170*	2170*	7258
3.0m			4690*	4690*	3850*	3850*	3380*	3380*	2160*	2160*	7476
2.0m			5430*	5430*	4280*	4280*	3640*	3640*	2210*	2210*	7554
1.0m			5950*	5950*	4630*	4630*	3860*	3840	2280*	2280*	7498
0m	4360*	4360*	6180*	6180*	4840*	4840*	3990*	3790	2430*	2430*	7303
- 1.0m	6730*	6730*	6160*	6160*	4870*	4870*	3990*	3780	2660*	2660*	6958
- 2.0m	7590*	7590*	5870*	5870*	4680*	4680*	3750*	3750*	3040*	3040*	6438
- 3.0m			5240*	5240*	4120*	4120*			3600*	3600*	5455

LIFT CAPACITIES – DIPPER LENGTH: 3.00M, 5.00M T.A.B., REAR DOZER, NO BUCKET. JSI45W T.A.B.

Reach	3m		4m		5m		6m		Capacity at Max Reach		mm
											
Load Point Ht.	kg	kg	kg	kg	kg	kg	kg	kg	kg	kg	mm
6.0m					2580*	2580*	2650*	2650*	2180*	2130	6896
5.0m			2870*	2870*	2780*	2780*	2730*	2700	2080*	1880	7405
4.0m	3910*	3910*	3480*	3480*	3140*	3140*	2920*	2640	2040*	1730	7751
3.0m			4270*	4270*	3590*	3350	3190*	2560	2040*	1640	7956
2.0m			5080*	4390	4060*	3200	3480*	2470	2070*	1600	8030
1.0m			5720*	4190	4470*	3080	3740*	2400	2140*	1600	7977
0m	4660*	4660*	6090*	4070	4760*	2990	3940*	2340	2270*	1640	7794
- 1.0m	6340*	6210	6200*	4020	4880*	2950	4010*	2310	2460*	1740	7472
- 2.0m	7990*	6250	6060*	4020	4810*	2940	3920*	2310	2770*	1910	6991
- 3.0m	7290*	6340	5620*	4070	4460*	2980	3500*	2350	3110*	2220	6315









 Lift capacity front and rear.

Notes:

1. For lifting capacity including bucket, subtract total weight of bucket or bucket and quickhitch from above values.
2. Lifting capacities are based on ISO 10567, that is: 75% of minimum tipping load or 87% of hydraulic lift capacity, whichever is the less. Lifting capacities marked* are based on hydraulic capacity.
3. Lift capacities assume that the machine is on firm, level ground.
4. Lift capacities may be limited by local regulations. Please refer to your dealer.

 Lift capacity full circle.

LIFT CAPACITIES – DIPPER LENGTH: 3.00M, 5.00M T.A.B., REAR STABILISERS, NO BUCKET. JSI45W T.A.B.

Reach	3m		4m		5m		6m		Capacity at Max Reach		mm
											
Load Point Ht.	kg	kg	kg	kg	kg	kg	kg	kg	kg	kg	mm
6.0m					2580*	2580*	2650*	2650*	2180*	2180*	6896
5.0m			2870*	2870*	2780*	2780*	2730*	2730*	2080*	2080*	7405
4.0m	3910*	3910*	3480*	3480*	3140*	3140*	2920*	2920*	2040*	1970	7751
3.0m			4270*	4270*	3590*	3590*	3190*	2900	2040*	1870	7956
2.0m			5080*	5070	4060*	3660	3480*	2820	2070*	1820	8030
1.0m			5720*	4860	4470*	3540	3740*	2740	2140*	1820	7977
0m	4660*	4660*	6090*	4730	4760*	3450	3940*	2680	2270*	1870	7794
- 1.0m	6340*	6340*	6200*	4680	4880*	3400	4010*	2650	2460*	1980	7472
- 2.0m	7990*	7430	6060*	4680	4810*	3390	3920*	2650	2770*	2180	6991
- 3.0m	7290*	7290*	5620*	4730	4460*	3430	3500*	2690	3110*	2540	6315

LIFT CAPACITIES – DIPPER LENGTH: 3.00M, 5.00M T.A.B., FRONT DOZER, REAR STABILISERS, NO BUCKET. JSI45W T.A.B.

Reach	3m		4m		5m		6m		Capacity at Max Reach		mm
											
Load Point Ht.	kg	kg	kg	kg	kg	kg	kg	kg	kg	kg	mm
6.0m					2580*	2580*	2650*	2650*	2180*	2180*	6896
5.0m			2870*	2870*	2780*	2780*	2730*	2730*	2080*	2080*	7405
4.0m	3910*	3910*	3480*	3480*	3140*	3140*	2920*	2920*	2040*	2040*	7751
3.0m			4270*	4270*	3590*	3590*	3190*	3190*	2040*	2040*	7956
2.0m			5080*	5080*	4060*	4060*	3480*	3480*	2070*	2070*	8030
1.0m			5720*	5720*	4470*	4470*	3740*	3510	2140*	2140*	7977
0m	4660*	4660*	6090*	6090*	4760*	4470	3940*	3440	2270*	2270*	7794
- 1.0m	6340*	6340*	6200*	6190	4880*	4420	4010*	3410	2460*	2460*	7472
- 2.0m	7990*	7990*	6060*	6060*	4810*	4410	3920*	3410	2770*	2770*	6991
- 3.0m	7290*	7290*	5620*	5620*	4460*	4450	3500*	3460	3110*	3110*	6315

LIFT CAPACITIES – DIPPER LENGTH: 3.00M, 5.00M T.A.B., FRONT STABILISERS, REAR STABILISERS, NO BUCKET. JSI45W T.A.B.

Reach	3m		4m		5m		6m		Capacity at Max Reach		mm
											
Load Point Ht.	kg	kg	kg	kg	kg	kg	kg	kg	kg	kg	mm
6.0m					2590*	2590*	2800*	2800*	2120*	2120*	6380
5.0m			2670*	2670*	2750*	2750*	2810*	2810*	2050*	2050*	6928
4.0m			3290*	3290*	3100*	3100*	2990*	2990*	2030*	2030*	7297
3.0m	5220*	5220*	4130*	4130*	3580*	3580*	3270*	3270*	2050*	2050*	7514
2.0m	6950*	6590*	5020*	5020*	4100*	4100*	3580*	3580*	2120*	2120*	7593
1.0m	7730*	7730*	5770*	5770*	4560*	4560*	3860*	3860*	2240*	2240*	7536
0m	7680*	7680*	6250*	6250*	4900*	4900*	4080*	3870	2430*	2430*	7342
- 1.0m	8720*	8720*	6430*	6430*	5060*	5000	4170*	3840	2720*	2720*	6999
- 2.0m	8400*	8400*	6320*	6320*	4990*	4990	4040*	3830	3190*	3190*	6483
- 3.0m	7680*	7680*	5850*	5850*	4580*	4580*			3720*	3720*	5746

 Lift capacity front and rear.

 Lift capacity full circle.

Notes:

1. For lifting capacity including bucket, subtract total weight of bucket or bucket and quickhitch from above values.
2. Lifting capacities are based on ISO 10567, that is: 75% of minimum tipping load or 87% of hydraulic lift capacity, whichever is the less. Lifting capacities marked* are based on hydraulic capacity.
3. Lift capacities assume that the machine is on firm, level ground.
4. Lift capacities may be limited by local regulations. Please refer to your dealer.



ONE COMPANY, OVER 300 MACHINES.

Your nearest JCB dealer

Wheeled Excavator JS145W

Engine power: 97kW (130hp) Bucket capacity: 0.23 – 0.78m³

Operating weight: 14,615 – 17,226kg

JCB Sales Limited, Rokeceter, Staffordshire, United Kingdom ST14 5JP.

Tel: +44 (0)1889 590312 Email: salesinfo@jcb.com

Download the very latest information on this product range at: www.jcb.com

©2009 JCB Sales. All rights reserved. No part of this publication may be reproduced, stored in a retrieval system, or transmitted in any form or by any other means, electronic, mechanical, photocopying or otherwise, without prior permission from JCB Sales. All references in this publication to operating weights, sizes, capacities and other performance measurements are provided for guidance only and may vary dependant upon the exact specification of machine. They should not therefore be relied upon in relation to suitability for a particular application. Guidance and advice should always be sought from your JCB Dealer. JCB reserves the right to change specifications without notice. Illustrations and specifications shown may include optional equipment and accessories. The JCB logo is a registered trademark of J.C. Bamford Excavators Ltd.

